

TRAINING PACKAGE ON BIOPHYSICAL SOIL AND WATER CONSERVATION MEASURES ON HILLSIDE/DEGRADED LAND

PART ONE: TECHNICAL MANUAL ON PHYSICAL SWC MEASURES ON HILLSIDE/DEGRADED LAND



January 2014
Ministry of Agriculture
Addis Ababa, Ethiopia

Table of Contents

MODULE 1: LEVEL SOIL BUND	1
1.1. Concept.....	1
1.2. Design, Layout and Construction.....	2
1.2.1. Technical standards and design steps	2
1.2.2. Layout and construct steps for level soil bund.....	4
1.3. Integration and maintenance for level soil bund.....	5
1.4. Major issues not to be forgotten and common mistakes	7
MODULE 2: STONE FACED SOIL BUND	9
2.1. Concept.....	9
2.2. Design, Layout and Construction.....	11
2.2.1. Technical standards and design steps for stone faced soil bund	11
2.2.2. Layout and construct steps for stone faced soil bund.....	12
2.3. Integration and maintenance of stone faced soil bund	13
2.4. Major issues not to be forgotten and common mistakes	14
MODULE 3: STONE BUND.....	15
3.1. Concept.....	15
3.2. Design, Layout and Construction.....	17
3.2.1. Technical standards and design steps for the construction of stone bund	17
3.2.2. Layout and construct steps for stone bund.....	19
3.3. Integration and Maintenance for stone bund.....	21
3.4. Major issues not to be forgotten and common mistakes	22
MODULE 4: FANYA JUU	23
4.1. Concept.....	23
4.2. Design, Layout and Construction.....	24
4.2.1. Technical standards and design steps for the construction of Fanya juu bund ...	24
4.2.2. Layout and construction steps of Fanya Juu	27
4.3. Integration and maintenance for Fanyaa juu bund.....	27
4.4. Major issues not to be forgotten and common mistakes	28
MODULE 5: BENCH TERRACE.....	30
5.1. Concept.....	30
5.2. Technical standards and design steps for bench terrace	33
5.2.1. Minimum technical standards.....	33
5.2.2. Layout and construct steps for bench terrace.....	34
5.3. Integration and maintenance of bench terrace.....	36
5.4. Major issues not to be forgotten and common mistakes	36
MODULE 6: HILLSIDE TERRACE	38
6.1. Concept.....	38
6.2. Design, Layout and Construction.....	39
6.2.1. Technical standards and design steps for the construction of hillside terracing ..	39
6.2.2. Layout and Construct steps for Hillside Terracing	39
6.3. Integration and Maintenance of hillside terracing.....	40
6.4. Major issues not to be forgotten and common mistakes	41

MODULE 1: LEVEL SOIL BUND

1.1. Concept

Description of level soil bund

Level soil bunds are physical conservation measures simply constructed from the soil across the slope and along the identified contour. It is similar with that of faniyaa juu, except for throwing the excavated soil from the excavated ditch/channel to the lower side of the ditch. Level soil bunds are impermeable structures and need to be constructed with spillways to manage the retaining of rainfall that can destroy the structures. The levelled soil bund does not need to have channel grade. The channel and the embankment are built level so that runoff is stored along the terrace. The ends of the levelled soil bunds are usually closed. However, sometimes it can be left open or partially open. The outlet may be a grass waterway, vegetated area or a stabilized gully.

The level soil bund with complete or partial end closures can be used *only on highly permeable soils* capable of absorbing the runoff rapidly enough to prevent damage to the physical structure and crops. On less permeable soils *no end closures* are used. This type of soil bund is adapted to areas of low to moderate rainfall generally not to exceed a 750mm annual rainfall depending upon soil depth and texture.

Purpose of level soil bund

The main objectives of constructing level soil bund are:

- to cut longer slopes into series of small slopes to decrease velocity of runoff,
- to increase time of concentration and infiltration rate mainly to contribute for conservation of soil and water,
- to retain and accumulate water in trenches dug above bunds for periods of long time to allow water to infiltrate, reduce run-off and erosion,
- to increase the moisture retention capacity of the soil profile and water availability to plants,
- to increase the efficiency of fertilizer applications and increase agricultural yields,
- to ensure crop production even during the drought time,
- to create an opportunity for further stabilization and application of organic residues or compost to the soil,

Time to construct level soil bund

Level soil bund is expected to be carried out during dry season, when there is no/less labor competition for other seasonal activities. It has to be accomplished before the next rainy season.

Appropriate locations for the construction of level soil bund

Level soil bund is commonly practiced in dry and moist Weyna dega areas under traditional systems. In most cases, level soil bund is suitable in **semi-arid** and **arid** parts of the country. It is also applicable in medium rainfall areas with well drained soils.

It can be applied to cultivated lands with slopes above 3 -15% gradient and on grazing lands with gentle slopes at wider intervals (up to 5% slope). It can be applied also on sloping homestead areas combined with cash crops.

1.2. Design, Layout and Construction

1.2.1. Technical standards and design steps

The following technical standards should be strictly applied/followed during the construction of levelled soil bunds.

Minimum technical standards

- **Height:** min. 60 cm after compaction.
- **Base width for stable soil:** 1-1.2m and (1 horizontal: 2 vertical),
- **Base width for unstable soil:** 1.2-1.5m in unstable soils (1 horizontal:1 vertical),
- **Top width:** 30 cm (stable soil) - 50 cm (unstable soil).
- **Channel:** shape, depth and width vary with soil, climate and farming system.
- **Ties (if appropriate):** Mostly ties with 20-30cm width dimension as required placed every 3-6 m interval along channel. Sometimes the width may be greater than 30cm,
- **Berm:** with 15-20cm at lower edge of the ditch,
- **Length of bund:** 30-60 m in most cases, higher (max 80m) on slopes 3-5% - need to be spaced staggered for animals to cross.

Stable soil is a type of soil that resists disintegration and/or movement from one place to another when an external force is applied to it. For example, clay soil is more stable than sandy soil.

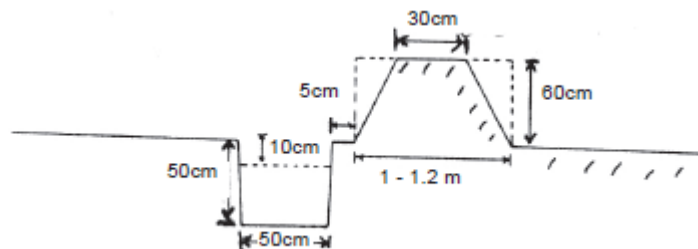

Figure 1: Technical drawing of soil bund for stable soil

Unstable soil is the soil that can easily lose its integration as the result of the application of external forces. For example, sandy soil is unstable when it is compared with clay soil.

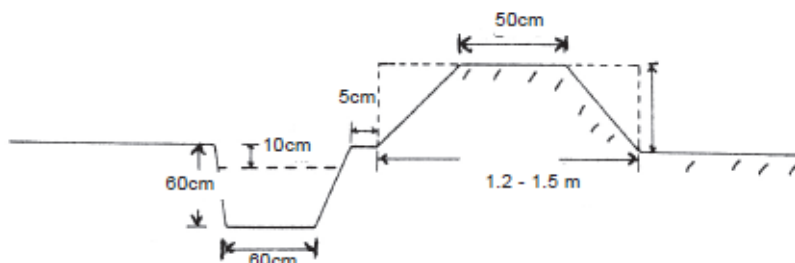

Figure 2: Technical drawing of soil bunds for unstable soil

Participants: Compare and contrast the base width of both stable and unstable soils bund and reason out why it is necessary to implement this recommendation.

Design steps

- Precise layout along contours (level) using line level,
- Join the demarcated contour lines by scratching the line between them,
- Measure and clearly indicate 50cm below the scratched line to excavate the ditch,
- Then strictly follow up and implement the technical standards /recommendation/ indicated under sub-section of 6.

Some necessary and helpful modifications/adaptation to standard design

1. Bunds that cross depression points without following exact contour lines should be supported by reinforcements at the depression points.



Figure 3: Level soil bund reinforcement at depression point

2. Bunds following farm boundaries: “corner bunds”, reinforcement, keys, cut & fill applicable only in areas with slope < 5%

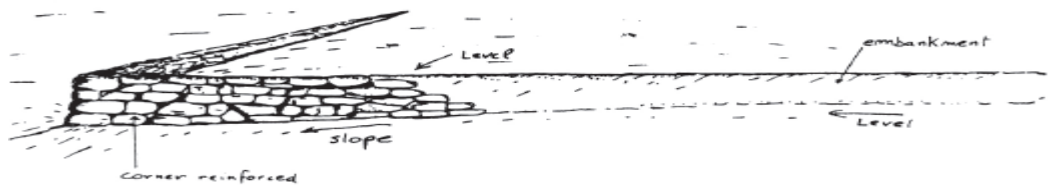

Figure 4: “Corner” bund reinforcement

3. In slopes < 3-5% and without lateral slopes bunds can be provided with spillways (lateral, side-check dam, gated, etc.).

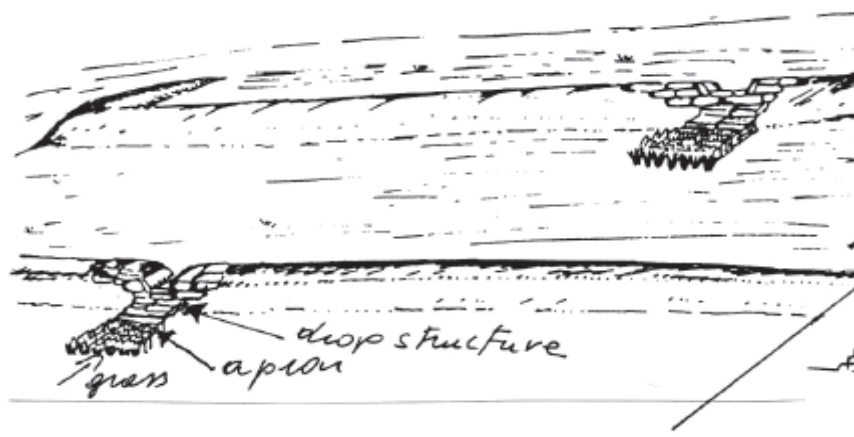

Figure 5: Spillways (lateral, side-check dam, gated)

1.2.2. Layout and construct steps for level soil bund

Layout is the process of determining the difference in elevation between various points mainly to measure distances and to set out contour lines by using different equipments such as a line level or A-frame. It helps to prepare appropriate layout for a given specific physical structure in accordance with its technical standards. Depending on the soil type, its permeability and impermeability, level soil bund can have either rectangular or/and trapezoidal layout. In addition, it is also possible to use other different equipments such as **line level, two range poles (graduated in 10cm) and 11 meters of string.**

Layout and vertical intervals relationship

Vertical intervals: follow a flexible and quality oriented approach:

- Slope ranges 3-8% will expect to have vertical intervals = 1-1.5 m
 - For example, if the specific area where you stand has vertical interval of 1m and slope percent of 8%, then what will be the horizontal distance of the soil bund?
 - Horizontal distance = $vi/slope\ \% = 1m/0.08 = 12.5m$,
- Slope ranges 8-15% will expect to have vertical intervals = 1-2 m
- Slope ranges 15-20% will expect to have vertical intervals = 1.5-2.5 m (only exceptional cases - reinforced).

Layout steps for level soil bund

The layout for level soil bund is expected to start from the top of the hill. Use the following procedure to carryout appropriate layout for level soil bund.

- a. Plant your initial peg at the top of the hill by ensuring and leaving adequate run-off area for your first bund,
- b. Use a line level or A-frame to measure your contour line and to identify different points on the same elevation,
- c. Identify your slope % (if it is less than or greater than 15%) to decide on your next Vertical Interval (VI),
- d. If the slope % is greater than 15%, then collect necessary data on soil depth by having sample excavation, observing soil profile in gully areas and requesting information from local people,
- e. Having adequate information on soil depth, identify your 2nd vertical interval by using $VI = 2.5 * \text{the soil depth}$,
- f. Before to begin the excavation, identify the soil type whether if it is stable or unstable and set marks.

On stable soil:

- g. Split the top width of the ditch into three equal parts (the central, upper and lower) by using pegs,
- h. Respectively mark the space for berm (15-20cm) and embankment (1-1.2m) on the lower side of the peg.

On unstable soil:

- i. On unstable soil type, the top width of the ditch is 70cm when compared with that of stable soil,
- j. Reduce 10cm from each side and indicate by peg. These spaces will be used latter on for reshaping,

- k. Then split the remaining 50cm into three equal parts as mentioned under step “g”,
- l. When you finalize the layout and agree up on the excavation, dig out 50cm width by 60cm depth 1st with a rectangular shape, and latter on reshaping the remaining 10 from each side at slant slope to produce trapezoidal shape,
- m. Before you start excavation, you need to indicate 15-20cm berm space on the lower side of the slope next to the 10cm peg on the downward side,
- n. Repeat the above procedures until you finalize the demarcated field,
- o. You need to apply reinforcements on depression points to avoid curving or cutting the plough line. Limit the bund length max 50-80m (the greater or the shorter the length of the slope) will affect the sustainability of the structure.

Other additional materials such as **shovels, pick axes, (the proportion of shovels and pick axes depend on type of soil) and wooden compactors** are also required to be avail during the construction phase.

Construction steps:

- Scratching or removal of grasses from where embankment/bund is going to be constructed for better merging & stability.
- Excavate the ditch start from the 1st contour line,
 - indicate the central, the upper and lower edges of the ditch,
 - indicate the width of the berm and bottom width of the soil bund,
 - the bottom width of soil bund can show variation depending upon the soil type (stable & unstable),
- The ditch should be excavated in a trapezoid shape to avoid downward sliding of the soil,
- Putting ties in place along channels at every interval of 3-6m,
- Identifying the soil type whether if it is stable or unstable to implement the technical recommendation accordingly,
- Keeping the height and the top width of the bunds in accordance with the recommendation given under sub-section (a),
- Essential to build, shape and compact the embankment/bund at every 15cm height ,
- Compacting the top of bunds and checking level with an A-frame (level bunds),
- Plant the top of the embankment with bund stabilization material (grass seed, grass sod or leguminous).

Work Norm: 150 Person days/Km

1.3. Integration and maintenance for level soil bund

Maintenance of level soil bund

The final goal of soil bund is to upgrade it to bench terracing through gradual maintenance. The upgrading can be undertaken by using soil from the lower part of bund (apply fanya juu principle to avoid fertile deposited soil to be used for the embankment).

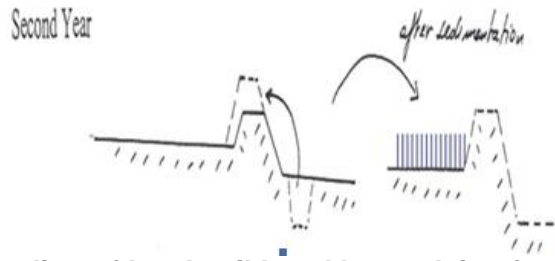

Figure 6: upgrading of level soil bund by applying fanya juu principle

Grow legumes on bunds and apply cut & carry for grass/legumes growing on bunds. Do not up root the plants on the bund. Rather cut them to use the above ground while the underground remaining part of the root will decay inside the bund to encourage grass growth.

The advantage of upgrading soil bund by using fanya juu principle is that during first year the bund can accommodate more sediments and water than the first year. At this time, the bund is less prone to breakages due to layout or construction errors. However, during the 2nd and consecutive years, it is possible to upgrade soil bund by excavating another ditch at lower side of the bund and upgrade the existing bund by throwing the soil upward. This should take place until the formation of bench terrace. Never use the deposited soil in the initial ditch to upgrade the soil bund. It is also possible to apply compost step by step by starting from the bund upward until you cover the whole spaces between the two bunds. The application of compost can take place year by year due to its scarcity.

Integration of level soil bund

In addition, to gain maximum output from level soil bund, it needs to be integrated with other physical and biological conservation measures. These are including:

Bund stabilization: Plant indigenous grasses such as Senbelete, “Dasho, others, etc. and legume shrubs such as Pigeon peas, Sesbania, Acacia saligna, etc. to stabilize the bund. In dense rows you can use direct sowing at a space of 15-30cm between plants. Pigeon peas can also be planted as annual crops.



Photo2: Soil bund plantation with Sesbania



Photo 1: Soil bund planted with grasses



Photo 3: Soil bund planted with pigeon

Agronomic practices: Contour ploughing is one of the important agro-technique to be incorporated with soil bund to make it more sustainable. Also it needs to apply compost (start 1st year applying 2-3 m strips above the bunds - where soil is deeper and moisture is



Photo 4: Contour ploughing

Growing cash crops along bunds: Composting is required to be applied in single or wider strips especially after 1-2 years to plant some cash crops. In addition to cash crops plant specific seasonal crops along bunds to use residual moisture (sunflowers, gourd, tomatoes, cucumbers, etc.).

Control grazing: avoid animals to graze between bunds. Rather, use cut and carry system to feed the biomass for the livestock.



Photo 5: Uncontrolled grazing

1.4 Major issues not to be forgotten and common mistakes

Major issues not to be forgotten

- negotiate with farmers before hand to select the site, layout and construction,
- carry out appropriate compaction of the embankment & putting berms accordingly,
- start the implementation of the layout of leveled soil bund in accordance with watershed principle,
- exclude steep slope (more than 30% slope) from soil bund construction, rather use vegetative barriers on such area,
- avoid free grazing.

Common mistakes

The following mistakes are often made:

- mostly not differentiating stable and/or unstable soil types,
- not scrapping away the top soil and rather leaving it buried under the bund embankment,
- appropriate compaction at every 15cm interval and leveling of the top edge is not fully done,
- the space for berm (15-20cm) between the edge of your ditch the soil bund is not accordingly implemented,

- some/all the technical recommendations under section 6 sub-section (a) is not fully implemented,
- effective maintenance during the 2nd and the 3rd year is not accordingly to change the soil bund to bench terracing,
- the physical structures is not supported with biological measures,
- cut and carry system is not implemented to make use of the forage plant on the bund,
- areal closure is not appropriately implemented,
- the rehabilitated areas are not linked with different IGAs to improve the livelihoods of the local community,
- appropriate clearing is not done on the construction sites,
- wings are not appropriately put at the ends of the bunds,
- appropriate compacting is not done very well,
- lack of due attention to encourage and help farmers in some areas who exercise the construction of soil bunds by their initiative and indigenous knowledge.

MODULE 2: STONE FACED SOIL BUND

2.1. Concept

Description of stone faced soil bund

Stone-faced soil bunds are embankments made from soil reinforced by stone wall risers in one or both sides, which are expected to be constructed along the contour. The embankment has water collection channel on its upper side. Stone faced soil bunds can be categorized into 3 different groups namely:

- single stone-faced soil bunds,
- double stone-faced soil bunds,
- “corner” or lateral stone/soil bunds

Single faced stone soil bund

The stone wall riser for a single stone-faced soil bund will start to be constructed at lower side of the bunds by inclining it towards the slope. Single stone-faced soil bunds are more stable when compared with double stone faced soil bunds. It has water collection trench /ditch/ at the upper side of the bund and berm with 15-20cm width between the lower edge of the trench and that of the bund foot. In case of the existence of depression points, reinforcement is required to be done to compensate for layout problems and to protect the entire length of the bund.

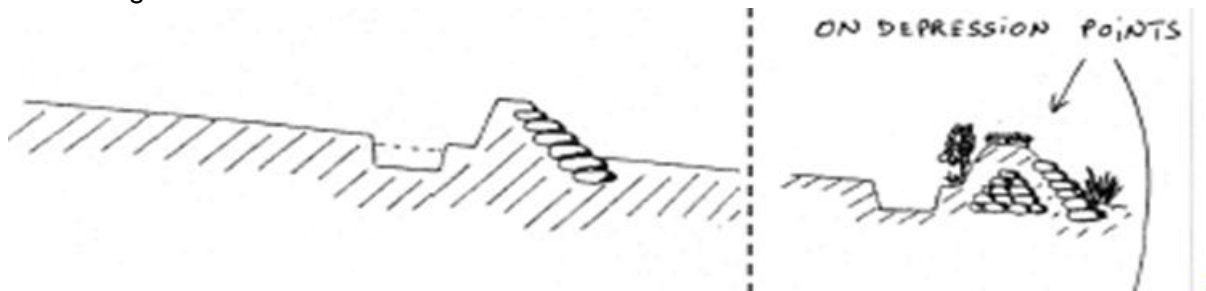

Figure 8: Single stone faced soil bund with depression points

Double faced stone soil bund

The stone wall riser for a double stone-faced soil will start to be constructed at lower and upper side of the bunds by inclining them towards each other. Double stone-faced soil bunds are stronger when compared with single stone faced soil bunds. Like that of the single stone faced bund, double stone faced bund has water collection trench /ditch/ at the upper side of the bund and berm with 15-20cm width between the lower edge of the trench and that of the bund foot. In case of depression points, reinforcement is required to be done to compensate for layout problems and to protect the entire length of the bund.



Figure 9: Double faced stone/soil bunds with collection trench



Photo 6: Double faced stone/soil bund

Source: Stone faced soil bund constructed at Tigray (WOCAT, 2003)

Corner stone or lateral stone faced soil bund

Corner stone soil faced stone bund is constructed from stones throughout its entire length. It is suitable for lateral field boundaries with gentle slopes (<5%). In this case, farmers may not expect to keep the contour line precisely. Rather, the bunds will be raised at those corners and strongly reinforced on both sides with stones. The tips of the bunds wing indicate upwards towards the slope. However, its height decreases while it is moving upward towards the slope. The bunds can also be provided with spillways to avoid excess water.

Purpose of constructing of stone faced soil bund

The main objective of constructing stone-face soil bund is to control runoff from causing soil erosion and to retain as much rainwater as possible in the soil for maximizing crop production and appropriate plant growth.

- offer strong resistance against runoff, and retain and accumulate water in ditches
- grass species planted to stabilize the bund can be used as a source of fodder for animals,
- fruit trees could be planted inside the ditch with ties or behind embankment can be used as source of cash crop to generate income for farmers,
- up on continuous follow up and upgrading, it forms bench terrace within short period of time.

Time to construct stone faced soil bund

Stone-faced soil bund is expected to be constructed during the dry season and before the beginning of the main rainy season to avoid labour competition for agricultural activities. It should be when the field is free following the crop harvest.

Suitability and agro-ecology for construction of stone faced soil bund

Successful implementation of stone-faced soil bund should be complemented by identification of appropriate land use, soil type, and texture and soil depth as well as topography assessment. It also needs to be implemented on areas with soil depth of 50-100 cm.

Stone-faced soil bunds are expected to be constructed where farmers are in need to construct the structure on their farm land and if there is adequate stones are available Stone-face soil bunds are suitable to wide range of agro-ecologies and with slope range up to 35%. It is also recommendable for dry areas, but needs to combine with other moisture conservation and fertility improvement measures such as tie-ridging and compost applications above bund or benched area.

2.2. Design, Layout and Construction

2.2.1. Technical standards and design steps for stone faced soil bund

Stone-faced soil bund has its own technical standards, design and construction steps, which are mentioned as follow.

Minimum technical standards

- **Grade of lower stone face:** 1 horizontal: 3 vertical;
- **Grade of upper stone face (if any):** based on soil embankment grade;
- **Grade of soil:** 1 horizontal to 1.5 vertical on stable soils and 1 horizontal. to 2 vertical on unstable soil;
- **Lower stone face riser foundation:** 0.3 depth x0.2-0.3 width;
- **Upper stone face riser foundation:** 0.2 x 0.2 m;
- **Stone size:** 20 cm x 20 cm stones (small and round shape stones not suitable);
- **Top width:** 0,4-0,5m;
- **Height:** min. 0,7 and max. 1 m (lower stone face); Channel or trench along bund;
- **Ties required:** at every 3-6 m along trench/channel for levelled stone-faced soil bund;
- **Sink hole:** is required at every 6-8 metre along the contour and staggered in its vertical alignment;

Design steps:

- Make sure contour lines /graded lines/ marked on the ground following VI/spacing determined during layout,
- Excavation should be clearly shown at lower side of the contour line with 0.3m depth X 0.3m width of foundation,
- Make sure the area for foundation excavation is properly marked (0.3m depth X 0.3 m width),
- Make ready and arrange stone with required for proper lank of risers,
- Ensure that the channel area is properly marked,
- Make that the tools required for construction stone soil bunds are in place,
- Follow the above all technical standard during the construction,

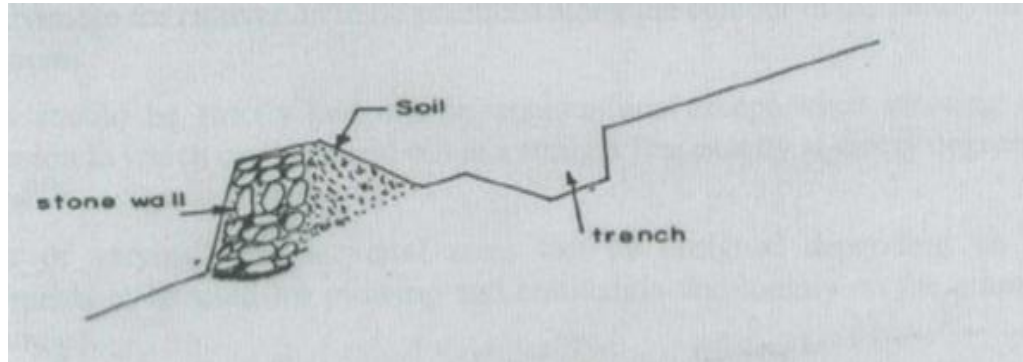

Figure 10: Technical drawing stone faced soil bund

Design modification

There also some modification/ adaptation to its standard design, which include:

- In case of depression points, reinforcement is required to be done to compensate for layout problems and to protect the entire length of the bund.
- Double stone faced bunds with and without stone key (relevant for reinforcements at depression points,
- Double faced stone/soil bunds without collection trench suitable in sandy soils and uniform terrains.
- They should not be longer than 50 meters and then provided with lateral spillways
- Stabilization of stone faced bunds and compost application

2.2.2. Layout and construct steps for stone faced soil bund

Precise layout along the contour line for levelled stone-face soil bund and graded line for grade stone faced soil is required. Discussion and agreement with farmers has also paramount importance before the under taking the lay out. The layout needs to include lateral wing in order to make effective water retention at the edge of the bund.

The lay out mainly depends on the slope of the land & its vertical interval. The following vertical intervals and slopes range will simply guide you to decide for horizontal distances to make the layout of hillside terracing.

- Slope 3-8% vertical interval = 1-1,5 m
- Slope 8-15% vertical interval = 1-2 m
- Slope 15-30% vertical interval = 1.5-2.5 m
- Above 30% slope only in very stable soils or shift to stone bunds.

The layout tools *include water line level, two range poles graduated in 10cm and 10 meters of string (a team of three people layout approx 2-3 ha/day).*

As it is the case for other soil conservation structural measures, the lay out for stone faced soil bund, will start by considering the spacing between terrace from the upper boundary line.

Construction steps:

- Collect stones/rocks and prepare them below the identified contour line,
- Scrape the soil from either side of the contour/graded line and remove the grass so that the soil can be easily compacted,

- Excavate the foundation as per the required technical standards and set the initial stones on angle towards the slope,
- Fill rocks /stones gradually in a manner that they fit and lock each other,
- Fill in the gaps with smaller stones and clayey soil to minimize leakage,
- The construction of stone faced soil bund need to undertake by mixing stone and soil alternatively at every 1/3rd of the layer of the total volume of construction until finalization,
- Soil excavated from the trench should make the bund step by step,
- The base of the rock wall must be always wider than the top,
- The inclination of the rock wall should be between 5-10 degrees from the vertical axis,
- Compact the embankment and level the top of the embankment,
- Move down to the next contour line and repeat the steps to construct the 2nd bund,

Work norm: 250Person Days/KM

However, it's practical construction needs equipments such as crow bars; sledge hammers shovels, and picks axes of shovels and pick axes depend on type of soil.

2.3. Integration and maintenance of stone faced soil bund

Maintenance for stone faced soil bund

Stone faced soil bunds can be upgraded through using the stone raiser after 1-2 years. In this case, it is essential that the foundation and the lower stone wall are well constructed.

In general, stone-faced soil bund needs to be integrated with other bio-physical measures to be sustain and fruitful.

Plant grasses, fodder plant leguminous to stabilize and make productive. Stone faced soil bunds are also used to grow fruit trees using the conserved moisture in the trench. Use cut and carry system for grass/legumes growing on bunds (never attempt to uproot them), composting and check on stability of stone raiser every 6 months/apply repairs as damage may occur. Stakeholders and/or farmers should have to take an initiative to limit or avoid free grazing.

Integration of stone faced soil bund

The integration of stone-faced soil bund with other biological conservation measures considers the following activities to be done.

Bund stabilisation: Planting splits of grass (indigenous such as “Sembelete”, “Dasho”, others, etc.) and seedlings of legume shrubs plants such as Pigeon peas, Sesbania, acacia saligna, etc.). In case of dense rows, you can use direct planting/sowing by using 15-30cm distance between plants on the upper side of bund and berm. Pigeon pea seedling can also planted as annual crops. Lower part of the stone wall can also be stabilized by planting drought resistant plants such as Sisal, Aloes and Euphorbia in thick rows.

Agronomic practices: contour ploughing and compost application (start first year applying 2-3 m strips above the bunds - where soil is deeper and moisture is higher).

Growing cash crops along bunds: (especially after 1-2 years of composting) in single or wider strips as required. You need to plant specific crops along bunds to use residual moisture (sunflowers, gourd, tomatoes, cucumbers, etc.).

Control grazing: avoid animals to graze between bunds for at least 1 year and place bunds in staggered position and do not end a bund in a depression point.

2.4. Major issues not to be forgotten and common mistakes

Major issues not to be forgotten

- discuss with communities and reach at agreement about group formation and by-law development,
- stabilize stone-face soil bund by planting different grass types such as Phalaris and elephant grasses,
- avoid free grazing and rather use cut and carry system,
- encourage farmer for farm closure,
- use of moisture to grow fruit trees,

Common mistakes

The following mistakes are often made:

- the first 10 cm of topsoil is not removed before starting excavation,
- starting stone-faced soil bund construction without confirming for full participation and commitment of local communities,
- beginning the construction of stone-faced soil bund before finalized the layout across the field,
- not considering all design criteria (planting, ditch, tie-ridge) during lay out,
- not constructing the foundation according to the required depth and contour line,
- the standard riser gradient is not followed,
- inadequate spacing of catchment area (i.e. distance between two consecutive terraces),
- stone size selection and proper laying is not followed.

MODULE 3: STONE BUND

3.1 Concept

Description of stone bund

Stone bunds are embankments to be constructed with stones along the contour line in combination with artificial waterways and traditional ditches to drain excess water. They are semi-permeable structures unless they will be sealed with soil in their upper side. Stone is the main construction input to be collected from the surrounding areas for the construction of this physical structure, while soil will be use as a sealing material. In some countries, where stone are not available, burned bricks or cement hollow blocks can be used as an alternative construction material. In stone bund construction, stones are expected to be built in an inclined position towards the slope of land to resist the pressure of run-off & form stable bunds.

Well-constructed stone bund will contribute for moisture infiltration into the soil to recharge the ground water, as well as, siltation accumulation at upper side of the stone bunds.

Bunds constructed from stone bunds are permanent assets which will give regular income if they are properly used for cultivation.

Dimension of the stone bund walls and spacing between them depends on various factors, especially on the slope and the amount of stone available in the field. The walls may be up to 1.25m high, from 1.0-1.5m in base width and 20-50m long. The spacing is expected to be 3-10m apart. Its design also varies from neatly built stone to merely piles of stones across the slope, which depends on the need of individual farmer. The walls can be built up each year with further stones, which may just be as more loose stone comes to the surface when ploughing carried out and/or by digging out larger stones to deliberate build up the height of the wall as it get up behind.



Photo 7: Stone bund

Stone bunds can have varying dimensions and undergo continuous upgrading after construction. The height of the stone wall increases with slope gradient. Bunds with cross depression points without exact following the contour line need to have reinforcement at depression points and key stones.

Purpose of constructing stone bund

Stone bunds help to protect soil and rain water loss. Stone bunds increase moisture retention to contribute for water table re-chargement and gradually for irrigation water availability. Together with contour ploughing, stone bund helps to keep soil fertility in place on steep sloping. Thus, it is required to be constructed for several purposes.

To mention some of them:

- to reduce and stop the velocity of runoff, soil erosion, decline in fertility and crop yields,
- to increase the moisture retention capacity of the soil profile and water availability to plants, and increase the efficiency of fertilizer applications,
- to ensure some crop production even in drought years,
- to use as an entry point for the application of organic residues or compost, especially in the first 2-3 meters behind the bund where soil is deeper,
- to retain and accumulate water in ditches dug behind the bund if necessary,
- to allow higher stability than soil bunds in slopes > 15%,
- to make use of abundant materials in the farm (eg. large stone).

In general, stone bunds silt up soon and converted to bench terrace in 5-6 years time, provided they are well maintained and upgraded on yearly basis.



Photo 8: Stone bund on cultivated land on the process of changing to bench terrace

Source: (WOCAT Documentation, 2000)

Some of its limitations are mentioned as follow:

- high labour investment for its establishment,
- stone bunds are tends to be irregularly shaped , making tractor & or oxen cultivation is impossible,
- stone bunds can temporary water logging if not integrated with fertility management,

- if too narrow spacing, the bund can take unnecessary space out of production and some rodents problems.

Time to construct stone bund

Stone bund is expected to be constructed during dry season and before the beginning of the main rainy season. This is to avoid labour competition for other seasonal agricultural activities.

Suitability and agro-ecology for the construction of stone bund

Stone bunds have wide range of suitability and adaptability. It can be applied to different agro-ecologies such as dry, semi-arid and arid parts of the country. It can be used in medium rainfall areas, on deep and well drained soils and moist weyna dega areas. In addition, it is also applicable to cultivated lands with some level of stoniness, to treat degraded hillsides and large gully networks combined with vegetative stabilization and tree planting.

3.1. Design, Layout and Construction

3.1.1. Technical standards and design steps for the construction of stone bund

Minimum technical standards for stone bund construction

- Height: 60-70cm up to 100 cm (lower side),
- Total Base width: (height/2) and (0.3-0.5 m).
- Top width: 30-40 cm.
- Foundation: 0.3 m width x 0.3 m depth.
- Grade of stone face downside: 1 horizontal: 3 vertical.
- Grade of stone face upper side: 1 horizontal: 4 vertical.
- Grade of soil bank (seal) on upper side: 1 horizontal: 1.5-2 vertical.
- Bunds need to be spaced staggered for animals to cross.
- Max bund length 60-80 meters.

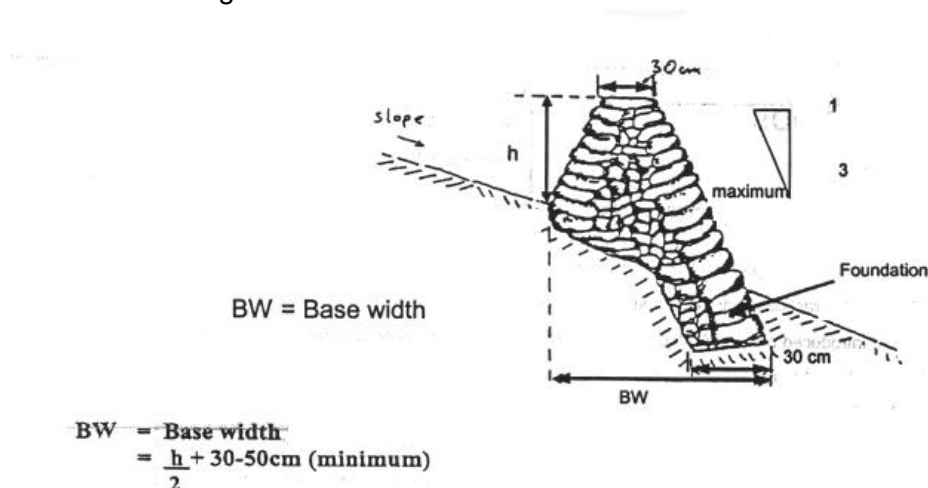

Figure 11: Technical standards of stone bund

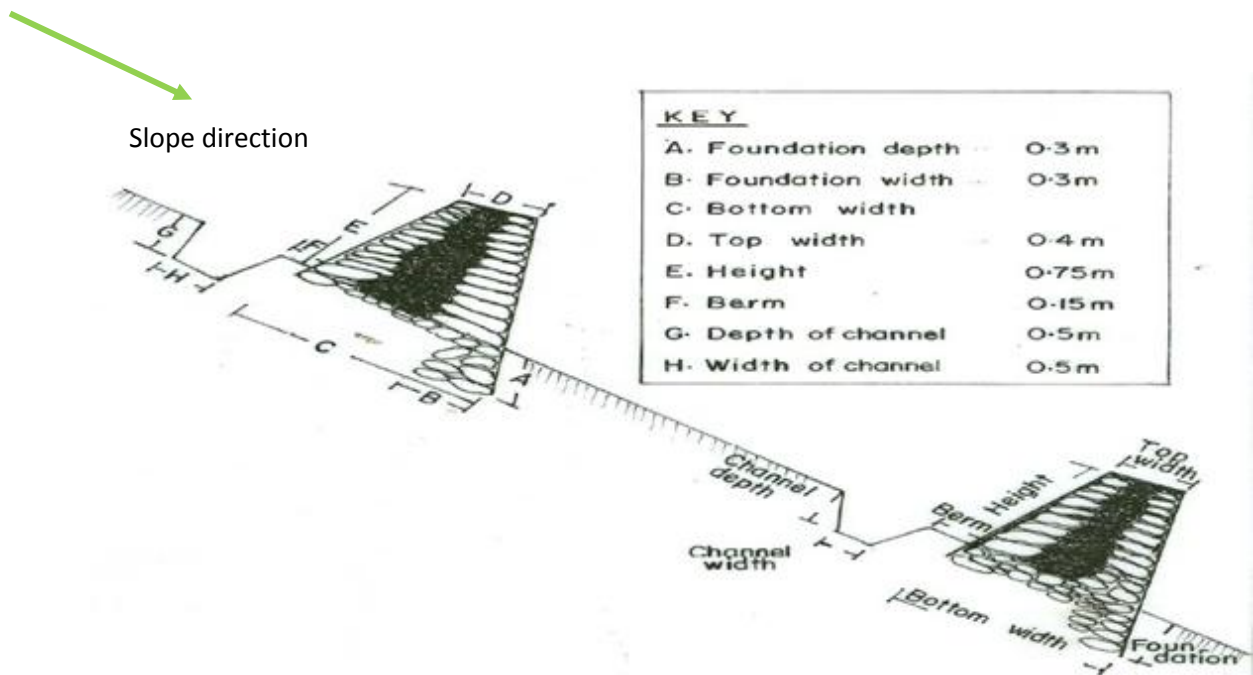

Figure 12: Technical drawing for stone bund

Design steps:

The design steps for stone bunds should be practically able to convert the above technical recommendation into practice at the ground level. Thus, the design steps for stone bund require to work upon the following points.

- make sure that the layout along contours (level) properly marked on the ground by using line level,
- join the demarcated contour lines (pegs) by scratching the line between them
- decide upon the vertical interval (VI) and the spaces between two stone bunds,
- decide on the base & top width and the length of the stone bund to be constructed,
- measure and clearly indicate 30cm below the scratched line to excavate the ditch,
- discuss also with farmers to decide about the spacing,
- ensure for the implementation of the technical recommendations indicated under sub-section of 6.

Modifications/adaptation to standard design:

1. Bunds that cross depression points without following exact contour lines should be supported by reinforcements at depression points,

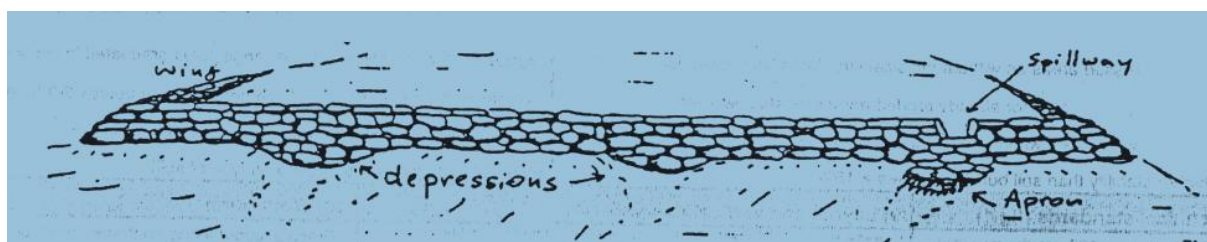

Figure 13: Stone bund with reinforcement at depression points and keys

2. Stone bunds with spillways (lateral, side-check dam)

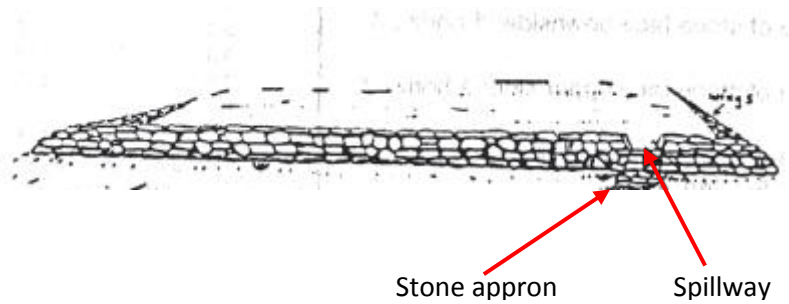

Figure 14: Stone bund with spillways

3. Stone bunds provided with trenches,

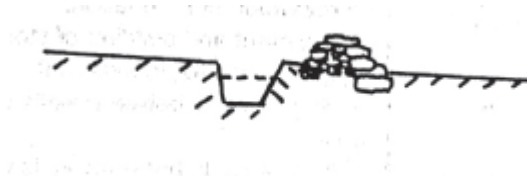

Figure 15: Integration of stone bunds with trenches

4. Stabilization of stone bunds and its gradual change to bench terrace,



**Photo 8: Stone bund on the process of being converted to bench terrace
(Source: Ethiocat, 2007)**

3.1.2. Layout and construct steps for stone bund

Layout and its essential tools:

To carry out appropriate lay out, you need to have one water line level or A-frame two range poles (graduated into 10cm) and 10 meters of string are needed.

Effective discussion should be made with farmers to reach at an agreement concerning the design and layout of the stone bund. The identification of land use, soil type, texture and soil depth, as well as, topography assessment are important to begin with the layout for stone bund construction. It is critically important to have precise layout along the contour line or graded lines during survey and design process. The layout of stone bund mainly depends on the slope of the land & its vertical interval. Use the following steps:

- Mark the contour line with pegs or stones,
- Determine your next contour line by using the vertical interval,
- Repeat the above procedures until you finalize the demarcated field.

The following table helps show the recommended vertical interval (VI) for stone bund construction.

Table 1: Recommended vertical intervals for stone bund construction

Ground Slope %	Height of bund (m)	Vertical Interval (m)	Distance apart (m)
5	0.5	1.00	20
10	0.5	1.50	15
15	0.75	2.20	12
20	0.75	2.40	10
25	1.0	2.50	8
30	1.00	2.6	8
35	1.0	2.80	6.0
40	1.0	2.8	5
50	1.15	2.8	4

Some class works:

1. If a given area is identified to have 5.3m horizontal distance and 30% slope, what will be about its vertical slope?
2. If an area is identified to have 50% slope and 1.25m vertical interval, what will be about its horizontal distance?

Construction steps

- Collection of larger stones, (but not small stones are allowed to be removed from the farm land). Removal of small stones from the farm will increase the occurrence of rill and sheet erosion on the farm land,
- Demarcate the line for stone bund construction along the contour line,
- Excavation of foundation base (30cmX30cm) at the lower side of the string or demarcation line,
- Placement and building of stone walls (larger stones should be used 1st for base construction).
- Continue to build the wall with stones until you reach at the required height,
- Incline the foundation towards the slope in such a way to withstand the pressure of runoff from the above,
- Filling of space between walls with smaller stones and sealing of upper side with soil as required,
- Small stone ties at every 5m is (optional),
- Reinforcement in depression points,
- Move down to the next contour line and repeat the steps
- Stabilization the bunds with grasses, fodder plants, legumes trees and application of compost

You need to have different equipments such as **crow bars, sledge hammers, shovels and pick axes** during construction phase.

3.2. Integration and Maintenance for stone bund

Maintenance for stone bund

In general stone bunds need to be upgraded to form bench terracing through gradual maintenance. It is obvious that, during the first year of construction of the stone bund, small amount of soil can be deposited at the upper side of the stone bund. The amount of soil deposition will increase during the 2nd- 3rd year, which requires upgrading of the stone bund with additional some stones to increase the height of the bund. Thus, after five years the slope between the two bunds will be changed to bench terrace with no more occurrence of any erosion.

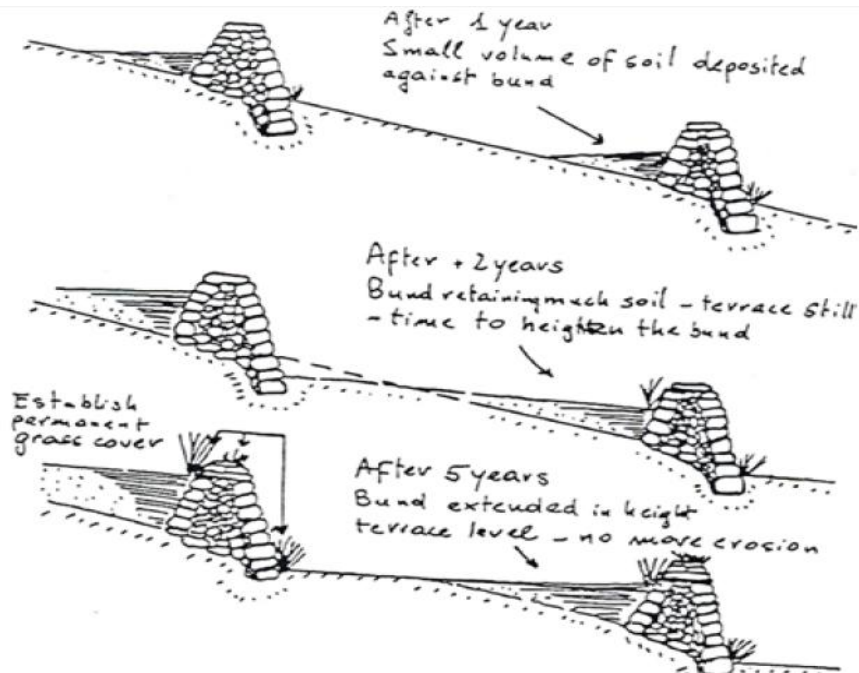

Figure 16: Gradual steps in maintaining stone bund and its change to bench terracing

Thus, it is necessary to carry out:

- Close supervision to take necessary remedial actions on time.
- Bunds need to be maintained regularly.
- It is important to raise the height of the bunds while upgrading or maintaining them.
- Apply cut & carry for any grass and forage crops growing on stone bunds (sealing the broken side with soil).

Integration of stone bund:

Integration opportunities/requirements: Stone bunds alone are not economically viable. They need to be combined with vegetative and agronomic measures (contour ploughing, applying organic fertilizers).

Bund stabilisation: Planting grass splits such as “Sembelete”, “Dasho” and others local grasses at the upper and lower side of the bund near to the stone to stabilize the bund. At the lower side, it is possible to plant some legume shrubs such as Pigeon peas, Sesbania, Acacia saligna, to provide the grass with natural fertilizer from the legumes and to stabilize the bund. In case of dense rows you need to use direct sowing at the space of 15-30cm on

sealed soil. Stone bunds can be stabilized further by planting drought resistant plants such as sisal, aloes and euphorbia placed on the low and/or upper side of the stone bund.

Agronomic practices: It is important to carry out contour ploughing and compost application (starting from first year applying 2-3 m strips above the bunds) where the soil is deeper and moisture is higher.



Photo 9: Stone bund strengthened with Elephant Grasses (left) and Simple wash line made of stones and straws /Konso indigenous knowledge (right)

- **Growing cash crops:** planting specific cash crops such as sunflowers, gourd, tomatoes, cucumbers, etc... along bunds to use residual moisture.
- **Control grazing:** avoid animals to graze between bunds for at least 1 year and place bunds in staggered position and do not end a bund in a depression point.

3.3. Major issues not to be forgotten and common mistakes

Major issues not to be forgotten

- integrate fertility management with stone bunds to avoid temporary water logging,
- make the space too narrow space in order to avoid unnecessary space wastage the problems of rodents.

Common mistakes

The following mistakes are often made:

- reinforcements at depression points and keys for those that cross depression points without following exact contour lines are done accordingly,
- different forage and multi-purpose trees are not used to stabilize the stone bunds,
- staggered position and spillways are not placed accordingly,
- collecting and use of small stones from the farm land, which can contribute to the formation of rill and sheet erosion,
- Exercising free grazing.

MODULE 4: FANYA JUU

4.1. Concept

Description of Fanya Juu bund

Fanya juu is simply a terrace bund built in association with a ditch, along the contour lines or a gentle lateral/on the side gradient in which the soil is thrown upward to form embankments /bunds. It is mainly used to regulate water availability in the soil to increase production and productivity. In Kiswahili, Fanya juu means throwing it upwards while in Amharic, it is called *Gilbit Irken*. It is constructed by digging ditches and heaping the soil on the upper sides to the fanya juu bunds, which is often stabilized by planting fodder grasses. Mostly it is constructed from soil or soils strengthened with stone rise with a collection of channel or basin at its lower side. Based on the soil type, the cross sectional shape of fanya juu ditch can be rectangular or trapezoid.

A small piece of edge called “berm” with 15-20 cm should be left between the edge of the ditch and foot of bunds to prevent the sliding of soil back to the ditch. The space between the two fanya juu bunds will be governed by slope and soil depth.

In general, based on its depth soil can be categorized into the following different classes:

- Very shallow < 25 cm,
- Shallow 25 to 50 cm,
- Medium depth 50-90cm,
- Deep 90-150 cm,
- Very deep >150cm

Purpose of Fanya Juu construction

Fanya juu is required to be constructed mainly to regulate rain water availability within the soil either by conserving and/or by discharging extra-moisture. Thus, fanya juu helps:

- to reduce velocity of run-off rainfall, to increase soil moisture and water availability to plants,
- in the semi-arid areas, to hold rainfall and increase soil moisture for growing grasses and fodder plants ,
- in the sub-humid /surplus moisture, it helps to discharge excess run-off
- it builds up soil fertility due to high yield expected on the bund,
- to increase agricultural production and productivity,
- to increase the biomass production of grasses that can be used as a source of fodder for livestock.

The main advantage of fanya juu is derived from its capacity to become a bench terrace within a short period of years, as the result of sediment accommodation.

Time for the construction of Fanya Juu

Fanya juu is expected to be constructed during dry season and before the beginning of the main rainy season to avoid labour competition for agricultural activities.

Suitability and agro-ecology for the construction of Fanya Juu

Fanya juu terracing is commonly practiced on farm lands and in some cases on hillside/degrade lands, grass land and homestead areas. It has been practiced at different parts of the country over the past 2 decades.

In general, it is recommended to be constructed:

- in **moist weyna dega/medium** rainfall areas and **semi-arid areas** with deep and well drained soils,
- on cultivated lands with slopes range 3-15% gradient,
- on uniform terrains/flat land with deep soils that do not have traverse slopes (depressions),
- on grazing lands with gentle slopes at wider intervals (up to 5%),
- on slope homestead areas combined with cash crops.

Thus, very shallow soils and very deep black clay soils are not suitable for fanya juu bund construction. Because very shallow soils do not have enough earth for building bunds while very deep black clay soils show different character during the wet and dry time. Soils with such type of character are not recommendable for bund construction.

4.2. Design, Layout and Construction

4.2.1. Technical standards and design steps for the construction of Fanya juu bund

It needs to make effective discussion should be made with farmers and agreement should be reached upon the design and layout. Fanya juu construction requires its own, technical standards, design and construction steps, which is mentioned as follow.

Minimum technical standards for the dimension

- **Height:** min. 60 cm after compaction.
- **Base width for stable soil:** 1-1.2m (1 horizontal: 2 vertical),
- **Base width for unstable soil:** 1.2-1.5m (1 horizontal: 1 vertical).
- **Top width:** 30 cm (stable soil) - 50 cm (unstable soil).
- **Collection ditch:** 60cm width by 50cm depth for unstable
- **Collection ditch:** 50cm width by 50cm depth for stable
- **Berm space:** 15-20cm,
- **Ties:** placed every 3-6 m interval along channel for level fanya juu,
- **Sink holes placed every 6-8m** along channel for graded fanya juu,
- **Length of bund:** up to 60 m in most cases, max 80 m,
- Fanya juu need to be staggered to allow animals movement during the land preparation.

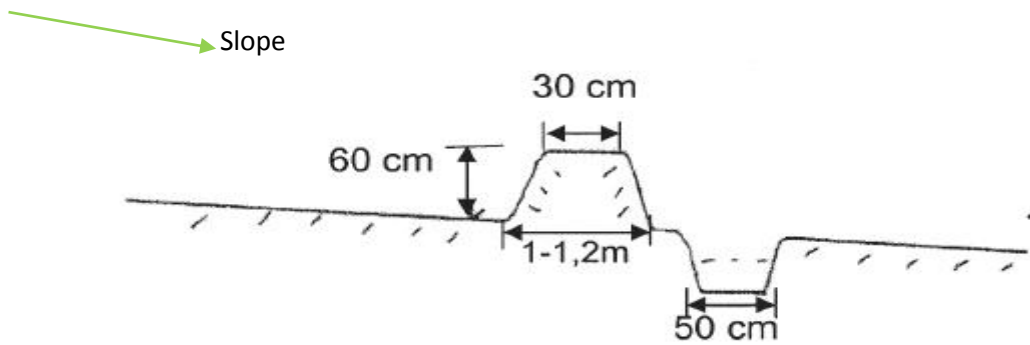

Figure 17: Fanya juu bund technical standard on stable soil

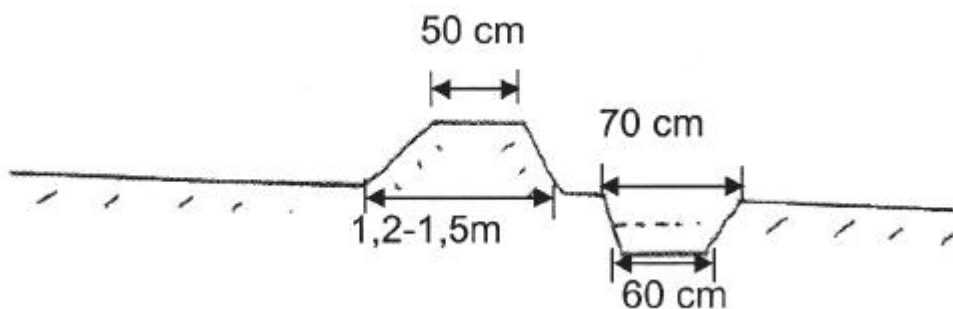

Figure 18: Fanya juu bund technical standard on unstable soil

Design steps:

- make sure that the layout along contours (level) or gradient (graded) using line properly marked on the ground,
- join the demarcated contour lines (pegs) by scratching the line between them,
- make sure that the distance below the scratched line to excavate ditch is 45-50cm,
- make sure the space for berm (15-20cm) at upper side (edge) of the ditch is properly marked,
- Discuss also with farmers to decide about the spacing,
- Then strictly follow up and implement the technical standards/recommendation indicated under sub-section of 6.

Modified design

1. Combination of Fanya juus and soil bunds and reinforcements within the same contour line may be used to address the problem of slight traverse slope/depression points,

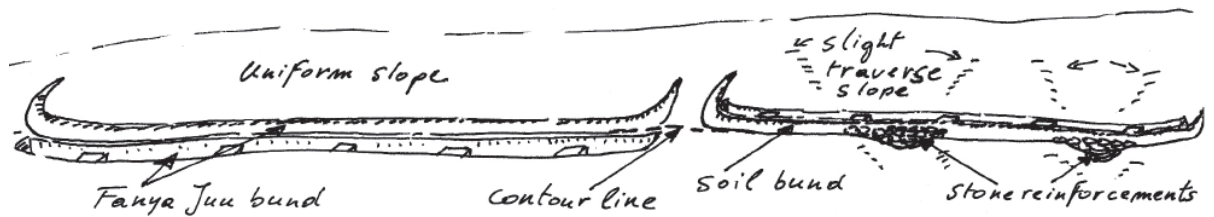

Figure 19: Combination of fanya juu with soil bunds reinforcement along slope

2. Combination of Fanya juus and soil bunds along the slope. This method is to allow some excess runoff. It is recommended that construction of fanya juu need to be alternatively made with soil bund in not captured by the fanya juu to get trapped by the upper trench of the soil bund.



Figure 20: Combination of Fanya juus and soil bunds along the slope

3. Upgrading of soil bunds by using the fanya juu principle.

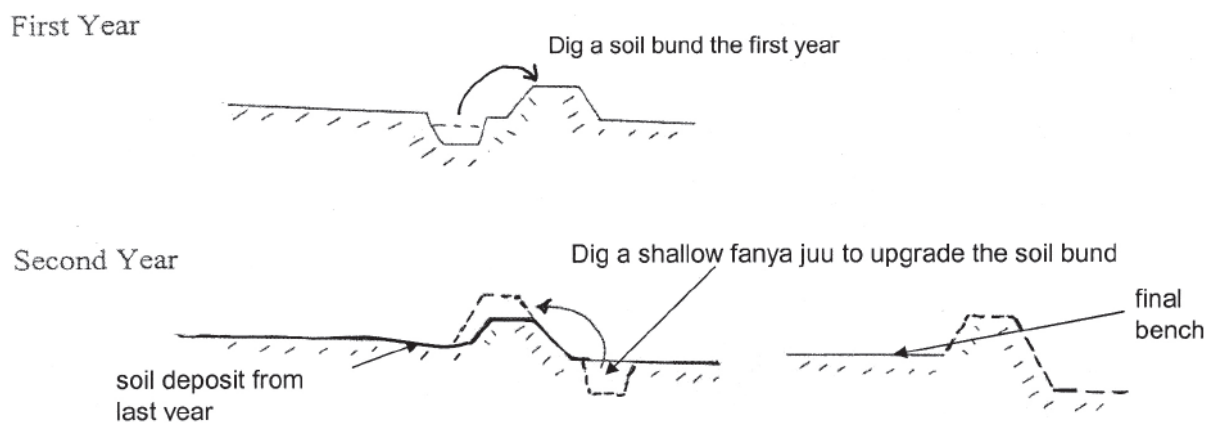

Figure 21: Fanya juu principle to upgrade soil bund and to change it to bench terrace

4.2.2. Layout and construction steps of Fanya Juu

Effective discussion should be made with farmers and agreement should be reached upon the design and layout of fanya juu bund construction. The identification of land use, soil type, texture and soil depth, as well as, topography assessment are important for the implementation of fanya juu construction. It is critically important to have precise layout along the contour line or graded lines during survey and design process.

- For slope 3-8% use vertical interval 1-1.5m,
- For slope 8-15% use vertical interval 1-2m,

Start the lay out by leaving the space equal to the distance between consecutive bunds from the upper edge of the plot. The lay out will include marking of contour/graded lines, the embankment and ditch space and the berm.

Tools for layout:

Layout along the contours can be prepared with some survey equipments such as ***water line level, two range poles graduated in 10cm and 10 meters of string.*** The layout and vertical intervals should be flexible and quality oriented. In case of the existence of lateral slopes shift the structure to soil bunds for higher water accumulation and apply reinforcements. The vertical interval for fanya juu construction varies in accordance with the slope range.

Construction steps:

- Identifying the soil whether if it is stable or unstable to keep the technical recommendation of base width of the bund as given for stable and unstable soil under (a),
- Scratching or removal of grasses from where embankment/bund is going to be constructed for better merging & stability and compaction of the soil,
- Excavate the ditch with 50cm depth and 50cm width for stable and 50 cm by 60cm unstable and throw the soil upward of the ditch /slope/ and pile the soil and form the embankment on the marked area,
- The ditch should be excavated in a trapezoid shape to avoid downward sliding of the soil,
- Putting ties in place along channels at every interval of 3-6m for levelled fanaya juu,
- Construct sink holes at every 6-8 along the channel for graded fanya juu,
- Keeping the height, the top width, and the berm size of the bunds in accordance with the recommendation given under sub-section (a),
- Compact and properly level the top of the embankment,
- Move down to the next graded line to repeat the same procedure.

4.3. ***Integration and maintenance for Fanyaa juu bund***

Maintenance of Fanya Juu bund

Fanya juu needs continuous upgrading for the first consecutive three years. If managed and maintained appropriately, on gradual bases, it will be changed to level terraces. The upgrading should use soil accumulated in the ditch below the bund to maintain the structure. It is also important to carry out maintenance of the breakages immediately after showers, especially in the first year. Agreement should be made by individual land owner to treat his/her land by fanya juu and farmers should take full responsibility to manage and maintain

the fanyajuu terrace on their farm land and communal land after construction. As the result of tillage and sediment accumulation behind the bund, the fanya juu should be gradually developed into slightly forwarding- sloping or even level bench terraces.

The area should be closed from human and livestock interference. It should be planted and replanted with recommended multi-purpose trees and grasses. In addition, some supportive and supplementary agro-forestry plants should be planted immediately above the embankment or in the ditch below in drier areas, where runoff tends to concentrate. The planted seedlings and/grass splits needs weeding and watering. Apply cut & carry for grass/legumes growing on bunds, but never uproot them.

Integration of Fanyaa juu bund

Fanya juu contribute to increase productivity only if it is well managed and integrated with soil fertility improvement practices, particularly with vegetative stabilization and compost application. Thus, maintenance is critically important to stabilize fanya juu bund by:

- strengthen it with biological measures,
- protect the land from free grazing,
- use the plant grown on the bund by cut and carry system,
- give due attention to increase the height and strengthen the bund by removing soil from its lower part and putting on the top of the bund during dry period.

Bund stabilisation: Fanya Juu bund needs embankment stabilization in the upper side to allow excess water to over top without creating damage. Planting different grass species with other shrubs is most suitable for fanya juu bund stabilization. Plants like aloes and sisal combined with more productive shrubs (pigeon peas) are also recommended on upper and lower side of fanya juu.

Agronomic practices: contour ploughing and compost application (starting from first year apply 2-3 m strips above fanya juu - where soil is deeper and moisture is higher).

Growing cash crops on the bunds: It needs also to plant specific crops along bunds to use residual moisture inside ditches (sunflowers, tomatoes, cucumbers, etc.). Plantation of cash crops should start especially after 1-2 years of composting in single or wider strips as required.

Control grazing, staggered position of soil bunds: combination of Fanya juus and soil bunds to address the problem of slight traverse slopes/depression points. In this case, Fanya juus need to be alternate with soil bunds along the slope. This method will help you capture some excess moisture by the upper trench of the soil bund (see figure 3 above). Upgrading of soil bunds after 1-2 years using the fanya juu principle is critically important (see figure 4 above).

4.4. Major issues not to be forgotten and common mistakes

Major issues not to be forgotten

- discuss and agree with community on group formation and by-law development,
- plant different grass species such as Phalaris and Elephant grasse to stabilize fanya juu bund,
- avoid free grazing and use cut and carry system,

- implement area closure,
- to grow fruit trees by using moisture,
- use soil bund alternatively with fanya juu,

Common mistakes

The following mistakes are often made:

- the first 10 cm of topsoil is not removed before you start excavation,
- starting fanya juu bund construction without full participation and commitment of local communities,
- inappropriate checking for slope range and soil depth,
- starting construction of fanya juu bund before lay out is completed across the hillside,
- all design criteria (planting, ditch, tie-ridge) during lay out are not considered accordingly,
- construction of the foundation is not in accordance standard depth and contour line,
- staggering is not implemented accordingly,
- wings are missed at the end embankment.

MODULE 5: BENCH TERRACE

5.1. Concept

Description of bench terrace

It is stone embankment placed along the contour with land levelling in between two terrace walls to control soil erosion and increase rainwater retention. Bench terrace is a series of level or nearly level strips running across the slope. Bench terrace with stone walls (risers) are very common technology with ancient origin. It is found worldwide, on steep hillsides where erosion is a problem and stone is available. In general, bench terrace is characterized by steep slopes, high percentage of surface stoniness, low rainfall, as well as, shallow to moderately deep soils.

Unlike that of hillside terrace, bench terrace looks like steps. In bench terrace the steep slope undergoes radical change to give new and levelled landscape. The type of tillage determines its width. If the field operation is going to be managed manually, then its width can vary from 2-5m apart and if draft power is to be used it can be wider and larger. It will be constructed through the cutting and filling

of the steep slope, which requires several steps to achieve the final goal (see fig. 21-24).



Photo 11: Konso Bench terrace, Ethiocat (2007)

Types of bench terraces

Depending on the direction of slope, bench terraces are classified into level bench terraces, inwardly sloping terraces and outwardly sloping terraces. They are briefly explained as follow.

Level bench terrace

When the terrace is well levelled, it is called level bench terrace. **Level bench terraces** consist of level top surface and are generally used in low rainfall areas with highly permeable soils. Such type of level bench terraces are sometimes called irrigated bench terraces.

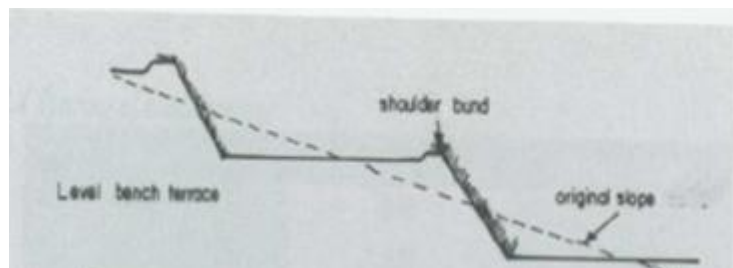

Figure 22: Technical drawing for level bench terrace

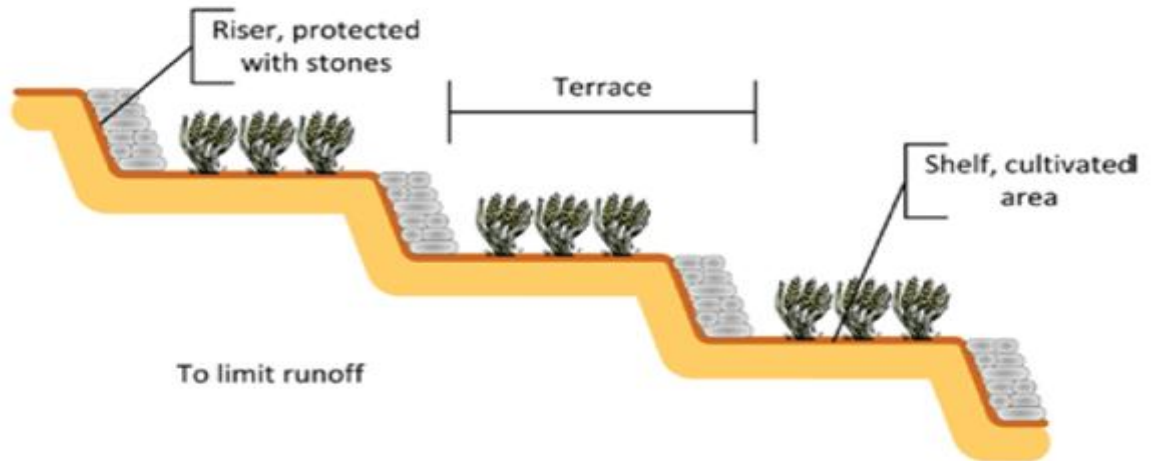

Figure 23: Level bund

Outwardly sloping

When the terraces are sloping outwards they are called outwardly sloping terraces. Sloping outward bench terraces are adopted in low rainfall areas with permeable soil. When crops like maize, potato, vegetable are grown they need drained soil. The slope is given to the terraces in order to drain out the excess rain water. In addition a shoulder bund is essential to provide stability to the outer edge of the terrace.

This type terraces are more suitable for the medium rainfall areas. The vertical intervals between the terraces are made very slanting and occupy some space. On these slopes one can plant fodder grasses like Napier grass or any other type of perennial grass which will retain the slope as well as give some yield of fodder

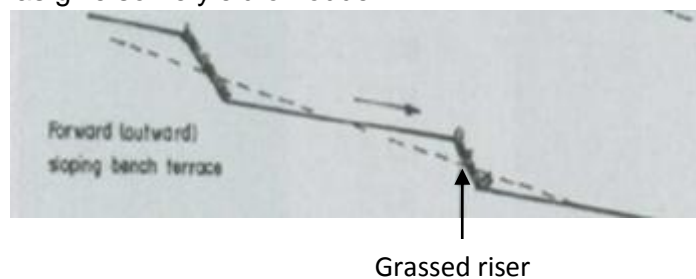

Figure 24: Technical drawing for forward /outward/ bench terrace



Photo 12: Outward sloping bench terrace formed from soil bund

Inwardly slopping

When the terraces are sloping towards the hill it is called inwardly slopping terraces. Each terrace in this case will slope towards the hill ending in a ditch or drain which will collect and sink the water into the soil. Bench terraces sloping inward are preferred in areas of heavy rainfall and less permeable soils, from where large portion of water is drained as surface runoff. Such a type of bench terrace has a provision to drain the runoff from its inner side by constructing a drainage channel. The terrace shows slightly slope (5-10%) towards the drainage

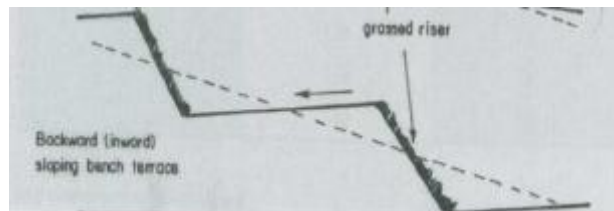

Figure 25: Technical drawing for inward bench terracing

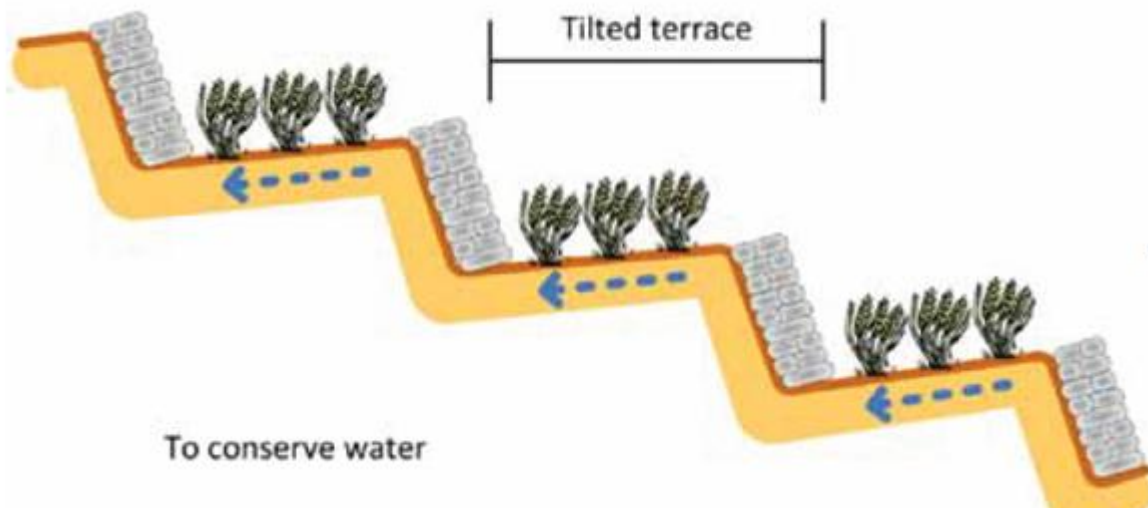

Figure 26: Inward bench terracing

Purpose for constructing bench terrace

The purpose of bench terrace is to break the slope length and reduce flow concentration to control soil erosion and enhance moisture conservation. Bench terraces are very efficient in preventing soil erosion and in retention of rainfall. They support the growth of trees in annual crops where they could not otherwise grow. Bench terrace is required to be constructed mainly to control runoff, to increase and maintain water storage in soil and/or to drain excess water. The main problem to initiate the implementation of bench terracing is the persistence of rainfall erosion that has resulted in shallow to medium alluvial soils formation on steep slope areas.

- it breaks the slope length and reduce flow concentration to control soil erosion and enhance moisture conservation,
- it converts a steep slope into a series of steps, with nearly horizontal benches to reduce velocity of runoff, reduce the soil erosion and the decline in crop yields embankments,
- it is a platform along a slope to create fertile condition for cultivation on the steep slopes,

- it helps to harvest sediment and to improve soil structure.

Bench terrace has some advantages and disadvantages. Some of its advantages are:

- it makes cultivation of trees on hillside possible,
- soil and water are conserved and fruit yields are increased,
- soil fertility will be gradually improved,
- if it is well established, its maintenance cost will be low. i.e. it needs little repair.

Some of its disadvantages are:

- establishment cost is very high, which is recommended to be compensated with the plantation of high value crops on the bund,
- Bunds are irregularly shaped and field operation is mainly limited to human labour i.e. the field is not conducive neither for tractor nor for oxen, as the result inadequate feed,
- Labour rate for initial establishment is too high.

Time to construct bench terrace

Bench terracing requires intensive labour for its implementation. Its construction needs appropriate time, when there is adequate labour .i.e. during dry season when labour competition for other seasonal activity is too low. In general, it is a traditional SLM practice whose wall is constructed from stones and supported at the down slope side by trees and legumes such as Pigeon pea, Coffee, Moringa, etc. It is constructed using local self-help group contribution /solidarity mechanism/ such as Debo,jigi or labour wage.

Suitability and agro-ecology for the construction of bench terrace

Bench terrace technology is characterized by steep slopes, high percentage of surface stoniness, low rainfall, and medium to moderately deep soils. Thus, bench terrace is recommended to be applied on different agro-ecology, topography and land use:

- in moist weyna dega/medium rainfall areas with deep and well drained soils,
- on cultivated lands with slopes above 3% and below 15% gradient, on grazing lands with gentle slopes at wider intervals (up to 5%),
- on sloping homestead areas combined with cash crops,
- in upper ranges of semi-arid areas on gentle slopes and well drained soils,
- on cultivated lands and unused steep hillsides of slopes of average 12 to 58% considering the various land use types (cereal, fruits, etc.).

5.2. Technical standards and design steps for bench terrace

5.2.1. Minimum technical standards

Bench terrace has its own minimum technical standards, which required to be fulfilled during its construction. The width, height and riser are critical elements for technical standards of bench terracing.

- **Width:** For areas to be cultivated by hands, the width of **2-5m** is suitable in making the bench. But in case animal driven cultivation it is possible to discuss and determine with farmers. In this case, more width may be implemented. The more the depth of soil and the less the slope, the wider space is expected.
- **Height:** The height of the riser (terrace) is the vertical interval (for a reverse slope the change in elevation across the terrace is subtracted).

- **Riser Ratio:** ratio of horizontal distance to vertical rise (1:1 in most cases). Can be stone faced, vegetated or grassed. Brush woods can also be applied along bench terraces.

Design steps

The key elements to be considered during the design process are both the slope and contour lines. You have to work hard on these two key elements to carry out appropriate design process for the construction of bench terracing.

Vertical interval is calculated as follows: $\text{vertical interval (meters)} = S \times W / 100 - SU$

- Where S is the land slope (%)
- W is the bench width (meters)
- U is the slope of the riser, expressed as the ratio of horizontal distance to vertical rise.

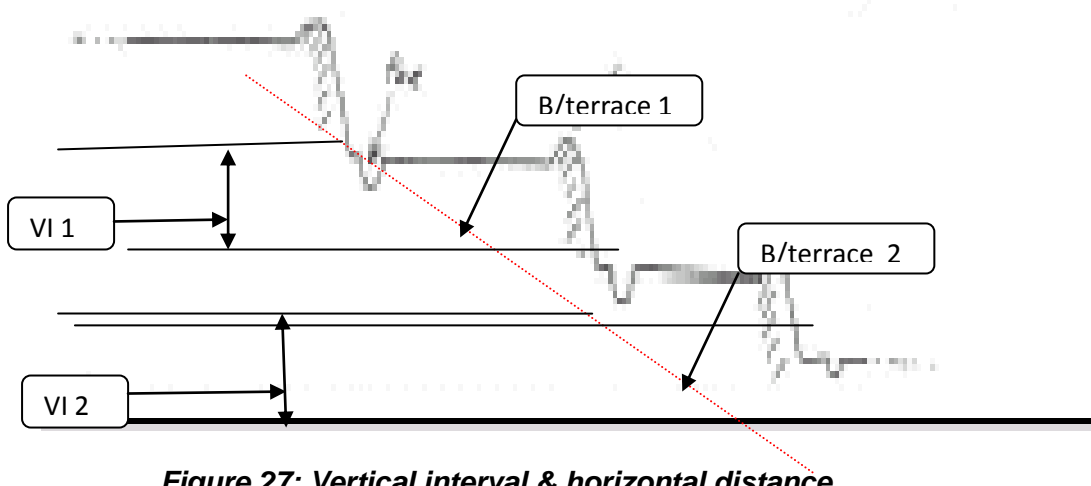

Figure 27: Vertical interval & horizontal distance

5.2.2. Layout and construct steps for bench terrace

Land use, soil types and depth, as well as, topography assessment should be conducted before the commencement of the construction. Precise survey/lay out is required to determine the construction lines along contour for construction of quality bench terrace. As it is common for other soil conservation structures, the layout for bench terrace will start from the upper part in considering the required spacing and continue down ward to the next row until completing the survey for a unit of land/plot (i.e. from top to bottom of the hill).

Layout: requires the involvement of 3 people (tailor, middleman and front man) work together to manage surveying related activities.

Tools required for layout: one water line level, two range poles graduated in 10cm, 10 meters of string, and bundles of pegs, scoop, hoe and spade.

Construction steps

The first step during establishment is to dig foundation up to 30 cm and place the stones on the trench to form the foundation of the stone-walls. The height of the terrace wall is in the range of 1.5-2 m high above the ground, and in some cases even more.

Steps:

- **Carry out careful survey and pegging on the contour line,**
- Collect adequate stone/ prepare brushwood, grass seed or seedling to get support for the riser from below,
- **Use A-frame or water tube level,**
- **Find the midline between the two contour lines (the upper and the lower) to determine the cut and fill areas of each bench terrace,**
- Decide the width and the vertical interval (height of riser), scratch middle line between pegs along the contour to demark the working line.
- **The upper area above the middle line will be the cut area while the lower below your middle line is the fill area,**
- **Excavate the ditch for the construction of the foundation,**
- **Preserve the upper layer of the soil that holds most of the nutrients,**
- **The construction should start from the lower and proceed upward,**
- **Reinforce the newly created bench terrace by locally available stone,**
- If appropriate, put ditches and drainage to dispose excess water ,
- The angle of the riser should be between 15° and 45° depending upon the type of soil and the riser height,
- Stabilizes the riser with grasses.

a) Peg the terrace

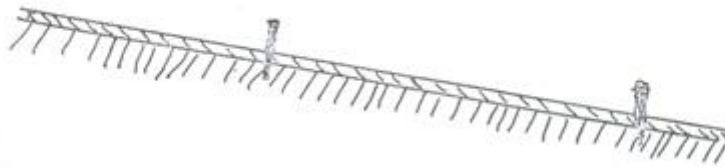

b) Throw the top soil to the center

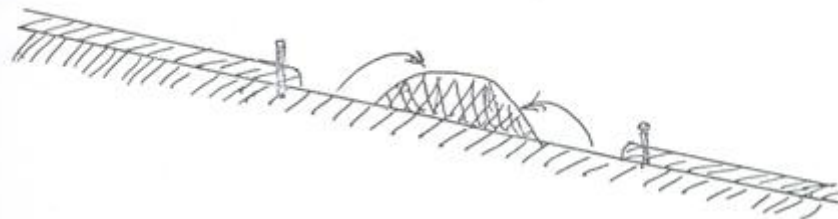

c) Excavate and level the subsoil

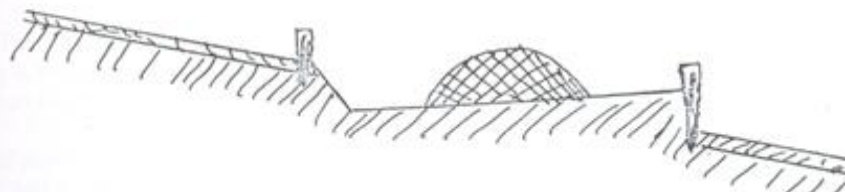

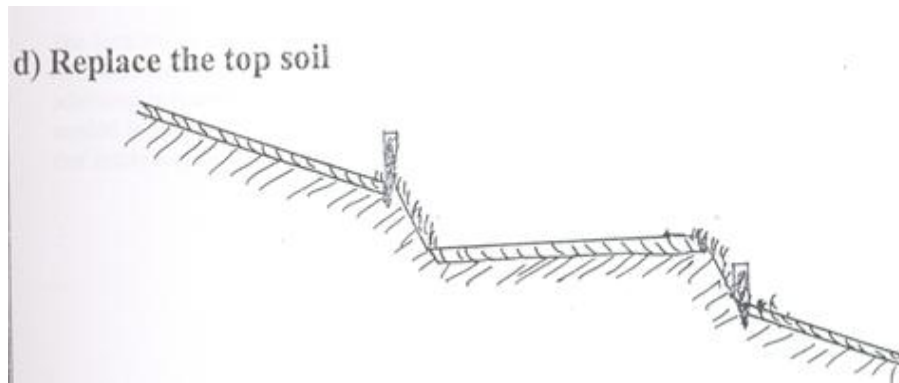

Figure 28: Steps for bench terrace Construction

Slope the new front area of the terrace slightly upwards. At the front of the terrace and on the top of the riser, construct a small mound or lip. This will prevent water from washing over the front and eroding the riser.

The norm required to accomplish this job is: **500 person per days/km**

It needs to integrate bench terrace with waterways to dispose off excess run-off from bench surfaces. If possible, stones otherwise brush woods should be used to support/reinforce the riser. Apply compost on each bench terraced land is critically important to increase yield. Planting grasses and legumes such as pigeon peas, tree Lucerne on the embankment will contribute to stabilize it.

Moreover, shovels pick axes and wooden compactors (the proportion of shovels and pick axes depend on type of soil) will be used during the **construction and levelling** process.

5.3. Integration and maintenance of bench terrace

Maintenance for bench terracing

Basically bench terrace is a traditional SLM practice whose wall is constructed from stones and supported at the down slope side by trees and legumes such as pigeon pea, coffee, moringa, etc. It is constructed for cultivation purposes. Thus, it needs continuous follow up to maintain some of its activities. Stabilizing by putting additional stones, planting multiple crops, repairing breached riser wall and replanting of vegetative materials are some of the activities to be considered during maintenance phase. Particularly risers need to be built /repaired/ where it is necessary. It should be planted and replanted with recommended type grasses and tree spp. The planted seedling and/grass splits needs also weeding and watering. Terraces also may need levelling.

5.4. Major issues not to be forgotten and common mistakes

Major issues not to be forgotten

- to discuss and agree with community on the importance of community mobilization, group formation and by-law development and its effective implementation,
- to support the physical structures with biological measures,
- to link the rehabilitated areas with different income generating activities (IGAs).

Common mistakes

The following mistakes are often made:

- not to remove the first 10 cm of top soil before you start excavation,
- implementing terracing without full participation and commitment of local communities,
- not distributed the excavated soil from the first 10cm evenly on the levelled areas,
- the wall of the riser is not planted with different grass species (particularly the Vetiver grass on the top of the lip),
- the legume hedgerows and Vetiver grass on the top of the riser are not constantly pruned and used to generate green manure or animal feeds.

MODULE 6: HILLSIDE TERRACE

6.1. Concept

Description of Hillside Terrace

Hillside terraces are physical structures constructed along the contour, generally suitable for steep slopes and shallow soils (although common in other type of soils) for tree planting. They are rather effective in controlling soil erosion and runoff. They are popular in the country, as well as, several dry zones of the world where trees are planted with perennial crops and fodder species.

Purpose of constructing Hillside Terrace

Hillside terraces are mainly constructed to rehabilitate degraded hillside areas and in the meantime to prevent damage of flooding the area below steep slopes. Constructing terracing on hillside/degraded land has several advantages.

- it divides /reduces the length of the slope,
- it minimizes the opportunity for the occurrence of sheet and rill erosion, as well as, further formation of gullies,
- it creates favourable conditions for tree planting and growth,
- it controls run-off and soil erosion,
- it increases water stored in the soil (improvement of ground water to contribute for irrigation development),
- it harvests sediment.

Time to construct Hillside Terrace

Hillside terrace construction is expected to be implemented during the slack and dry seasons, when there are no other seasonal agricultural activities to compete for the labour availability. In case of the existence of hard soils, which is difficult to be excavated during dry season, it can stay until the soil gets the first short rainfall.

Suitability and agro-ecology for the construction of Hillside Terrace

Hillside terrace is suitable for slope < 50% and well drained soils. Depending on the agro-ecological conditions of the area, it requires integration with different water harvesting structures for tree planting and erosion control.

In moisture adequate areas, it needs to be combined with trenches to contribute for the improvement of water shed rehabilitation, biomass production and recharging of water tables. Experts constructing this structure should take care of the catchment and cultivated area ratio mainly for run-off farming.

In dry areas and shallow soils, it needs to be combined with other measures such as eyebrow basin to conserve moisture for plant growth. In addition, its integration with biological conservation measures is also critically important to ensure its sustainability.

6.2. Design, Layout and Construction

6.2.1. Technical standards and design steps for the construction of hillside terracing

Hillside terrace construction has its own technical standards, design and construction steps mentioned as follow.

Technical standards

Terracing construction needs to fulfil the following technical standards.

- **Slope ranges:** vary from 20 - 50% although possible to observe on higher slopes,
- **Vertical interval varies:** from 2 - 3 meters,
- **Height or stone riser can vary minimum:** 0.5 m - 0.75 m,
- **Width of the terrace :** can vary 1.5 m – 2 m,
- **Foundation :** 0.3m depth and 0.3 m width,
- **Width of tie-ridge:** 0.15 cm - 0.20 cm,
- **Plantation pit:** 40 cm x 40 cm x 40 cm,
- **Tie should provided water spillway:** at every 5 metre option
- **Grade of stone riser:** well placed stone wall (grade 1 horizontal to 3 vertical)
- **Lip at the top of stone riser:** with 10 cm height,

In moisture deficit areas in most cases hillside terrace needs to have 5 – 10 % gradient back-slope to contribute for effective moisture conservation.

Design steps

You have to critically consider the following points during the design steps of hillside Terracing.

- Step1: Identify the slope range in accordance with the above technical recommendation,
- Step 2: Measure the slope
- Step 3: Decide the vertical interval based on slope range,
- Step 4: Estimate width of terrace: min 1,5 metre (range 1.5-2metre),
- Step 5: Estimate the height of the riser,
- Step 6: Decide the specific location for foundation base,
- Step 7: Estimate the pit size and decide the desired planting interval,
- Step 8: Decide the need for tie ridge, its width and interval,
- Step 9: The space between the tie ridges will be equivalent to the space between plants,

6.2.2. Layout and Construct steps for Hillside Terracing

Hillside terraces are recommended to be applied for erosion control and/or water conservation. Pre-implementation assessment should be carried out to identify its suitability and viability. Thus, precise survey/lay out is also critically important for its overall success.

The layout along the contours should be very accurate. **The vertical interval** varies from 2-3 meters while its horizontal spacing between terraces varies from 2.5-5.5 metres, respectively. The terrace is needed to be provided with **ties** particularly in moisture stress areas. Ties are made to avoid eventual lateral movements of water that may occur due to slight design errors during the layout. Hence, leaving space for the tie is required during lay out. The lay out includes also the area for planting pits (at least 40 cm x 40 cm x 40 cm).

The lay out for the starting point needs to consider the spacing b/n terrace from the upper boundary line. Then the lay out for plot of hillside should be completed before construction.

Different tools for survey/layout and construction of terrace are required. **The implementation of layout requires:** one water line level, two range poles divided into 10 cm, 11 m of string and bundle of pegs and hammer.

Construction steps

During the construction phase follow the next steps:

- Step 1: You need to go back to the 1st upper horizontal/contour line,
- Step 2: Remove the first 10 cm of topsoil and keep it for future use,
- Step 3: Dig a 30 x 30 cm (depth and width) foundation at the lower part of the strip,
- Step 4: Start construction of the stone wall with a height of 50-75cm and fill the space with the soil excavated from the ditch,
- Step 5: the stone wall should be inclined towards the slope,
- Step 5: Raise the wall and continue cutting the slope until you form a small terrace,
- Step 6: Place small ties at regular intervals with small spillway,
- Step 7: Repeat the same procedure the identified areas.

The practical construction of terrace requires: crow bars, sledge hammers, shovels, pick axes to facilitate the practical work at the site level. The ratio of shovel to pick axes depends on the soil type.

6.3. Integration and Maintenance of hillside terracing

Maintenance of Hillside Terracing

Hillside/degraded land terracing requires the implementation of several activities for its sustainability. In the 1st place, regulations and by-laws should be developed to control free grazing and protect the area from unnecessary human and livestock interference. This is the key element to ensure the success and sustainability of hillside /degraded land terrace. The treated area should be fairly allocated to different groups to ensure for proper management & maintenance of the implemented activities. The groups need to prepare and implement their own business plans to ensure productivity and sustainability of hillside terrace.

Integration of Hillside Terracing

Plantation on hillside terrace should be carried out timely with appropriate tree species. Weeding, cultivation and replanting should be part of the hillside terrace management activities.



Photo 13: Hillside plantation

6.4. Major issues not to be forgotten and common mistakes

Major issues not to be forgotten

Don't forget to:

- Discuss and agree with the community on group formation and by-law and business plan development as well as its effective implementation through an area closure strategy and good management,
- Plant multi-purpose trees,
- Integrate water harvesting structures.

Common mistakes

The following mistakes are often made:

- Not to remove the first 10 cm of top soil before you start excavation,
- Implementing terracing without full participation and commitment of local communities,
- Forgetting to start the construction of the terrace before the slope range and soil depth have been measured,
- Starting construction before the lay out has been completed,
- Not considering all design criteria (planting, ditch, tie-ridge) during lay out,
- Not to construct the foundation according to the required standard depth and contour line,
- Not to follow the standard riser gradient during construction,
- Not to leave space (distance between two consecutive terraces) in the upper part while defining the starting point for hillside terracing lay out.

References

1. Taffa Tulu (2011). Soil and Water Conservation for Sustainable Agriculture. Mega Publishing & Distribution P.L.C. Addis Ababa. Ethiopia.
2. MoARD (2010). Sustainable Land Management Technologies and Approaches in Ethiopia. Federal Democratic Republic of Ethiopia. EthioCAT. Ethiopia.
3. MoARD (2010). Physical Soil and Water Conservation Training Manual. Natural resources Directorate Oublic Work Coordination Unit. Wukro. Tigray.
4. Oromia-GIZ/SLM (2010). Physical Soil and Water Conservation Measures. Ambro. Oromia
5. IPMS (2009). Training Manual on agricultural water management. International Livestock Research Institute (ILRI). Addis Ababa. Ethiopia.
6. WOCAT (2007): where the land is greener: Case studies & analysis of SWC initiatives worldwide. (Page 249-297).
7. Mitku Haile, Karl Herweg, Brigitta Stillhard (2006): Sustainable Land Management-A New Approach to soil and water conservation in Ethiopia. Mekelle University. Mekelle.
8. MoARD (Jan 2005). Community Based Participatory Watershed Development: A Guideline. Federal Democratic Republic of Ethiopia. Addis Ababa. Ethiopia.
9. Tesfaye Beshah (2003). Understanding Farmers. Explaining Soil and Water Conservation in Konso, Wolaita and Wello, Ethiopia. Tropical Resource Management Paper. No. 41 (2003). Wageningen University and Research Centre.
10. Pretty J N (1995) Regenerating Agriculture: Policy and Practice for Sustainability and Self-Reliance. London. Earthscan.
11. MoA (1979). Soil and Water Conservation Guideline in Ethiopia for Development Agent. (*Amharic version*).